

User Manual

TH5500 All In One Home Energy Storage System

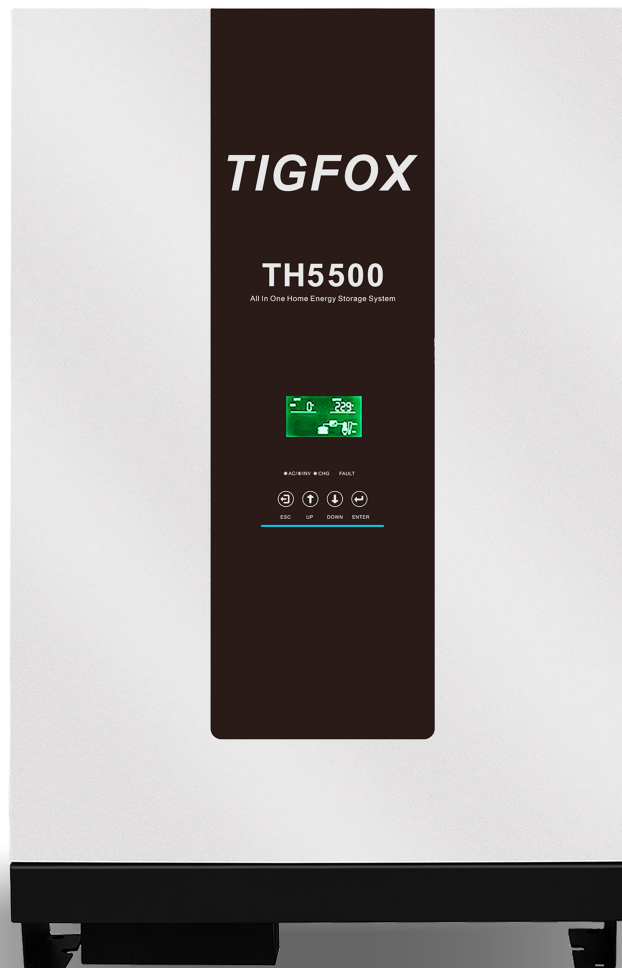

Table Of Contents

1. ABOUT THIS MANUAL.....	1
1.1 Purpose.....	1
1.2 Scope.....	1
1.3 SAFETY INSTRUCTIONS.....	1
2. INTRODUCTION.....	1
2.1 Features.....	2
2.2 Basic System Architecture.....	2
2.3 Product Overview.....	3
3. WIFI Connection (Optional).....	3
4. INSTALLATION.....	4
4.1 Unpacking and Inspection.....	4
4.2 Preparation.....	4
4.3 Mounting the Unit.....	4
4.4 AC Input/Output Connection.....	5
4.5 PV Connection.....	6
4.6 Final Assembly.....	7
4.7 Communication Connection.....	7
4.8 Dry contact signal.....	7
5. OPERATION.....	8
5.1 Power ON/OFF.....	8
5.2 Operation and Display Panel.....	8
5.3 LCD Display Icons.....	9
5.4 LCD Setting.....	11
5.5 Parallel function operation instructions.....	16
5.6 Fault Reference Code.....	18
5.7 Warning Indicator.....	19
6. TROUBLE SHOOTING.....	20
7. SPECIFICATIONS.....	23
Table 1 Solar Mode specifications.....	23
Table 2 Line Mode specifications.....	24
Table 3 Charge Mode specifications.....	25
Table 4 Inverter Mode specifications.....	26
8. BATTERY LCD INTRODUCE.....	27
9. BATTERY INFORMATIONS.....	28
10. Installation dimension drawing.....	31

1. ABOUT THIS MANUAL

1.1 Purpose

This manual describes how to assemble, install and operate the units and how to troubleshoot of this unit. Please read this manual carefully before installation and operation. Keep this manual for future reference.

1.2 Scope

This manual provides safety and installation guidelines as well as information on tools and wiring.

1.3 SAFETY INSTRUCTIONS



WARNING: This chapter contains important safety and operating instructions. Read and keep this manual for future reference.

1. Read and follow all installation, operation, and maintenance information carefully before using the product.
2. **CAUTION:** To reduce risk of injury, charge only deep-cycle lead acid type rechargeable batteries. Other types of batteries may burst, causing personal injury and damage.
3. Do not disassemble the unit personally. Take it to a qualified service center to repair.
4. To reduce risk of electric shock, disconnect all wiring before attempting any maintenance or cleaning, turning off the unit will not reduce this risk.
5. **WARNING :** Disconnecting all power supply before any maintaining or cleaning, please noted that if you only turn off the unit are not safe enough.
6. **WARNING:** Only qualified service persons are allowed to operate this product. If fault not solved after following troubleshooting table, please send this inverter back to local dealer or service center for maintenance.
7. **WARNING:** Because this inverter is non-isolated, only three types of PV modules are adaptable: single crystalline, poly crystalline with class A-rated and CIGS modules. To avoid any malfunction, do not connect any PV modules which likely with current leakage flow to the inverter. For example, grounded PV modules may cause current leakage flow to the inverter. When using CIGS modules, please be sure of NO grounding.
8. **CAUTION:** It's requested to use PV junction box with surge protection. Otherwise, it may cause damage on inverter.

2. INTRODUCTION

This is a multi-function inverter/charger; combining varies of functions of inverter, solar charger and battery charger. Supply uninterruptible e l e c t r i c energy to loads. It's comprehensive LCD display allowed user setting the varies date according to user's requirements, such as battery charging current, AC/solar charger priority, and setting different input voltage based on different applications.

2.1 Features

1. off grid inverter
2. Output power factor $\text{COS } \phi = 1.0$
3. On-grid with energy storage
4. Configurable AC/Solar Charger priority via LCD setting
5. Smart battery charger design for optimized battery performance
6. Compatible to mains voltage or generator power
7. Overload ,Over temperature ,Short circuit protection , battery low voltage
8. External WIFI devices
9. Parallel operation with up to 9 units

2.2 Basic System Architecture

The following illustration shows basic application for this inverter/charger. It also includes following devices to have a complete running system:

Generator or Utility. PV modules

Consult with integrators who provide you the system about the architectures as you request. this inverter can supply power to all kinds of appliances in home or office ,including motor-type appliances, such as tube light, fan, refrigerator and air-conditioner.

NOTE: The following picture is only a schematic diagram of the equipment .If the actual chassis does not conform to the schematic due to a structural upgrade, it is subject to prior notice.

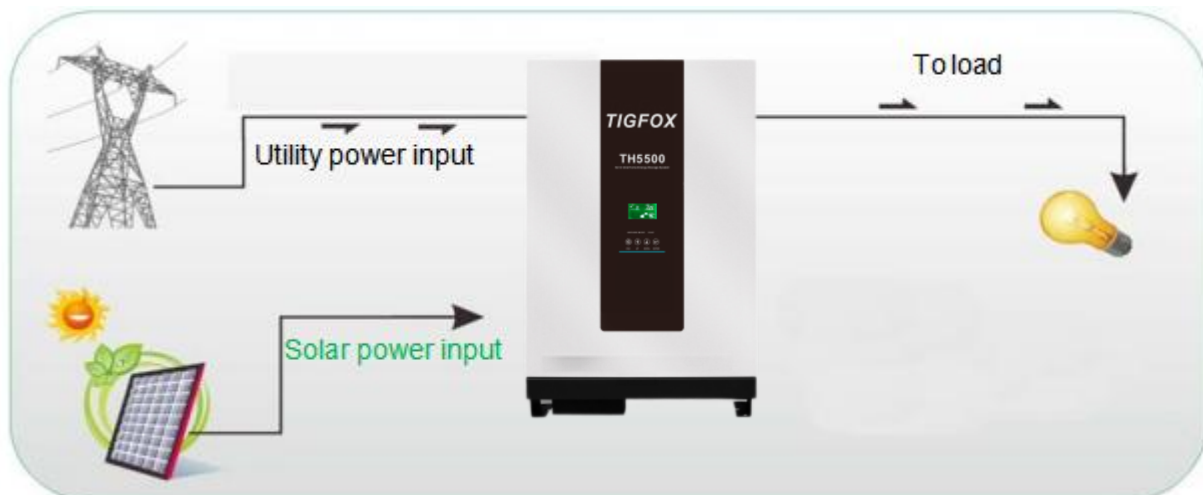

Figure 1 All In One Home Energy Storage System

2.3 Product Overview

NOTE: All the input and output ports are at the bottom of the product:



- | | |
|-----------------------------------|-------------------------------------|
| 1. AC input | 9. Battery Parallel port RS485 IN |
| 2. AC output | 10. Battery Parallel port RS485 OUT |
| 3. PV input | 11. Battery on/off switch |
| 4. Battery + (+51.2V) | 12. Battery -(GND) |
| 5. Inverter on/off switch | 13. WIFI port |
| 6. BMS CAN port | 14. Inverter RS232/RS485/CAN port |
| 7. BMS 485 port | 15. Inverter USB port |
| 8. RS232 port | 16. Inverter Generator dry contact |
| 17. Inverter Current sharing port | 18. Inverter Parallel port |

3. WIFI Connection (Optional)

Inverters come equipped with factory-integrated Wi-Fi capability which makes it very easy to integrate into a home network (Wi-Fi Dongle is Optional) This makes it ideal for local monitoring via the inverter's own wireless home network or for online monitoring platforms.

4. INSTALLATION

4.1 Unpacking and Inspection

Before installation, please inspect the unit. Be sure that everything in the package is not damaged. The following items inside of package would be received.

All In One Home Energy Storage System x1
User manual x 1
Communication cable x 1

4.2 Preparation

Please remove the two screws on the back cover of the device before opening it.

4.3 Mounting the Unit

Consider the below points before selecting where to install:

1. Do not mount the inverter on the surface of flammable construction materials.
2. Mount on the surface of a solid material.
3. Install this inverter at a visible place in order to allow the LCD display to be read at all times.
4. For proper air circulation and dissipate heat ,make sure there is 20 cm distance from the two side, 50 cm distance from bottom of the unit.
5. The ambient temperature should be between 0°C and 50°C to ensure optimal operation.
6. The recommended installation position is to be adhered to the wall vertically.
7. Be sure to keep other objects and surfaces as shown in the diagram to guarantee sufficient heat dissipation and to have enough space for collecting wires.

Suitable for mounting on concrete or other non-combustible surface only

4.4 AC Input/output Connection

CAUTION! Before connecting to AC input power source, please install a separate AC breaker between inverter and AC input power source. This will ensure the inverter can be securely disconnected during maintenance and fully protected from over current of AC input. The recommended spec of AC breaker is 63A for 5.5KVA. There are two terminal blocks with “IN” and “OUT” markings. Please do NOT connect input and output connectors wrong.

WARNING! All wiring must be performed by a qualified personnel. It's very important for system safety and efficient operation to use appropriate cable for AC input connection. To reduce risk of injury, please use the proper recommended cable size as below.

Model	Gauge	Cable (mm ²)	Torque Value
5.5KW	10 AWG	6	1.4-1.6 Nm

4.5 PV Connection

CAUTION: It is forbidden for inverter to share the same solar panel group.

CAUTION: Before connecting to PV modules, please install separately a DC circuit breaker between inverter and PV modules.

WARNING: It's very important for system safety and efficient operation to use appropriate cable for PV module connection .To reduce risk of injury ,please use the proper cable size as below.

Model	Wire Size	Cable (mm ²)	Torque value(max)
5.5KVA	12AWG	4	1.2-1.6 Nm

WARNING: Because this inverter is non - isolated, only three types of PV modules are acceptable : single-crystalline, poly crystalline with class A-rated and CIGS modules .To avoid any malfunction, do not connect any PV modules with possible current leakage to the inverter. For example, grounded PV modules will cause current leakage to the inverter. When using CIGS modules, please be sure NO grounding.

CAUTION: It's requested to use PV junction box with surge protection. Otherwise, it will cause damage on inverter when lightning occurs on PV modules.

PV Module Selection:

When selecting proper PV modules, please be sure to consider below parameters:

Open circuit Voltage (Voc) of PV modules not exceeds max. PV array open circuit voltage of inverter.

INVERTER MODEL	5.5KVA
Max. PV Array Open Circuit Voltage	450Vdc
PV Array MPPT Voltage Range	120Vdc~450Vdc

Application Example:

Solar Panel Spec. 250Wp Vmp: 30.1Vdc Imp: 8.3A Voc: 37.7Vdc Isc: 8.4A	SOLAR INPUT	Qty of panels	Total input power
	(Min in serial: 5 pcs, max. in serial: 11 pcs)		
	5 pcs in serial	5 pcs	1250W
	8 pcs in serial	8 pcs	2000W
	10 pcs in serial	10 pcs	2500W
	9 pieces in serial and 2 sets in parallel	18 pcs	4500W
	10 pieces in serial and 2 sets in parallel	20 pcs	5000W
	11 pieces in serial and 2 sets in parallel	22 pcs	5500W

PV Module Wire Connection

Please follow below steps to implement PV module connection:

1. Remove insulation sleeve 10 mm for positive and negative conductors.
2. Suggest to put bootlace ferrules on the end of positive and negative wires with a proper crimping tool.
3. Fix PV wire cover to the inverter with supplied screws as shown in below chart.



4.6 Final Assembly

After connecting all wires, please put bottom cover back by screws.

4.7 Communication Connection

Please use supplied communication cable to connect inverter and PC, follow the instructions on the screen to install the monitoring software. For the detailed software operation, please check user manual.

4.8 Dry contact signal

There is one dry contact (3A250VAC) available on the panel. It could be used to deliver signal to external device when battery reaches warning level.

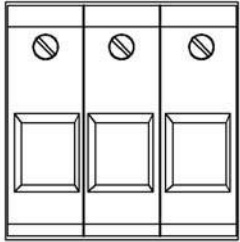
Unit Status	State	 NC C NO	
		NC & C	C & NO
Power off	Unit is off and no output is powered	Open	Close
Power on	Battery voltage $\leq 45.0\text{VDC}$	Close	Open
	Battery voltage $\geq 51.0\text{VDC}$, after 1 minute	Open	Close

5. OPERATION

5.1 Power ON/OFF

Once the unit has been properly installed and the batteries are connected well, simply press On/Off switch(located on the button of the case) to turn on the unit.

5.2 Operation and Display Panel

The operation and display panel, shown in below chart, is on the front panel of the inverter. It includes three indicators, four function keys and a LCD display, indicating the operating status and input/output power information.



LED Indicator

LED Indicator		Messages	
☀️ AC / ☀️ INV	Green	Solid On	Output is powered by utility in Line mode.
		Flashing	Output is powered by battery or PV in battery
☀️ CHG	Green	Solid On	Battery is fully charged
		Flashing	Battery is charging.
⚠️ FAULT	Red	Solid On	Fault occurs in the inverter
		Flashing	Warning condition occurs in the inverter







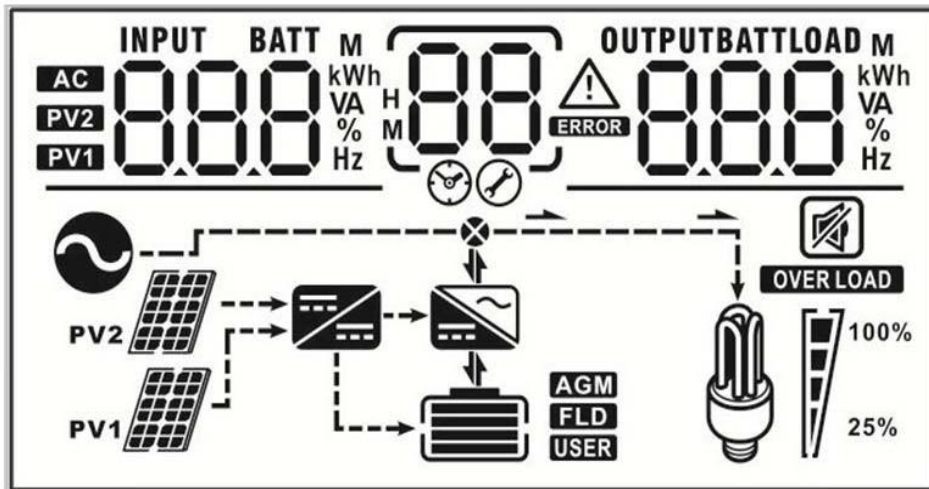





Function Keys

Function Keys	Description
ESC	To exit setting mode
UP	To go to previous selection
DOWN	To go to next selection
ENTER	To confirm the selection in setting mode or enter setting mode

5.3 LCD Display Icons



Icon	Function Description
Input source information	
	Indicates the AC input
	Indicates the 1 st PV panel input (Use only the PV1)
	Indicates the 2 nd PV panel input (PV2 is reserved for use)
Left digital display information	
	Indicates input voltage, input frequency, battery voltage, PV1 voltage, PV2 voltage, charger current
Middle digital display information	
	Indicates the setting programs
	Indicates the warning and fault codes warning: Flashing with warning code.
	Fault: display with fault code.





Right digital display information					
		Indicates the output voltage, output frequency, load percent, load VA, load W,DC discharging current			
Battery information					
		Indicates battery level by 0-24% · 25-49% · 50-74% · 75-100% and charging status.			
Load information					
		Indicates over load			
		Indicates the load level by 0-24% · 25-49% · 50-74% · 75-100%			
		0-24%	25-49%	50-74%	75-100%
					
Mode operation information					
		Indicates unit connects to the mains			
		Indicates unit connects to the PV panel			
		Indicates the solar charger is working			
		Indicates the DC/AC inverter circuit is working			
Mute operation					
		Indicates unit alarm is disabled . Press and hold the "ESC" key for 3 seconds .			
M		LCD display in master unit			
H		LCD display in slave unit			
88		Number of parallel machines			
E9		Battery equalization enable			





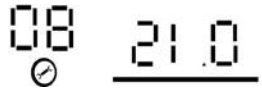
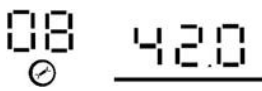
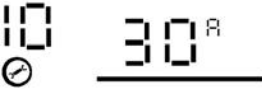

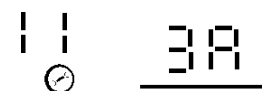
5.4 LCD Setting

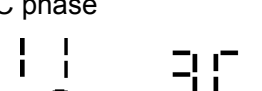
After pressing and holding ENTER button for 3 seconds, the unit will enter setting mode. Press “UP” or “DOWN” button to select setting programs. And then, press “ENTER” button to confirm the selection or ESC button to exit.

Program	Description	Selectable option	
00	Exit setting mode	Escape: 00 ESC	long press the ESC button for 3 seconds ,and the mute will turn on automatically
01	Output source Priority selection	Utility first(default) 01 UEL	Line: (default) Utility will provide power to the loads as the first priority, solar charging the battery. When solar energy is in sufficient,utility and solar energy charge the battery at the same time. When utility is unavailable,it will be powered by solar energy or batteries.
		Solar first 01 PUL	Solar: Solar energy provides power to the loads as the first priority. when the solar energy is sufficient, the extra energy will charge the battery . When solar energy is insufficient for load, batteries and solar will supply power the loads at the same time. When solar energy and batteries are insufficient or solar energy is unavailable, utility provides power to the loads and charges the battery at the same time.
		Battery first 01 SBU	Battery: Battery energy provides power to the loads as first priority. utility energy will supply power the loads only when battery.low-level warning voltage or the setting point.
		Utility and Solar 01 PAL	Solar + Line: Solar energy provides power to the loads as the first priority. If solar energy is not sufficient to power all loads, utility energy will supply power the loads at the same time.
02	Output voltage	220Vac 02 220	230Vac(default) 02 230
		240Vac 02 240	Note: after modify the output voltage,the device must be restarted.

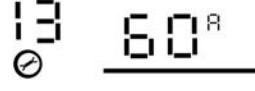
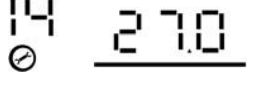
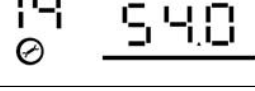
03	Output Frequency	50Hz(default) 03 50 _{Hz}	60Hz 03 60 _{Hz}
Note: after modify the frequency,the device must be restarted to be effective.			
04	Battery type	AGM(default) 04 AGM	
		Flooded: Lithium battery 04 FLd	1. If this option is selected , 39 alarm will appear when the CAN communication between the lithium battery and the inverter is disconnected. 2. If you have a lithium battery but not a lithium for CAN communication, you can choose "USE".
		No Battery 04 nbt	If inverter work without battery, program 04 must be set to <u>nbt</u>
		User-Defined 04 USE	If "User-Defined" is seleted.battery charge voltage and low DC cut-off voltage can be set up in program 05,06.
05	Bulk charge voltage	24V model default setting:28.0 05 28.0	Bulk charging voltage: 24V model:(default 28.0Vdc) setting range :24V to 30V setting increase or decrease of 0.1V. 48V model: (default 56.0Vdc) setting range :48V to 60V Please note: if self-defined is selected in Program 04,this program can be set up.
		48V model default setting:56.0 05 56.0	
06	Floating charge voltage	24V model default setting:27.0 06 27.0	Floating charge voltage: 24V model:(default 27.0Vdc) setting range :24V to 30V setting increase or decrease of 0.1V. 48V model: (default 54.0Vdc) setting range :48V to 60V Please note: if self-defined is selected in Program 04,this program can be set up.
		48V model default setting:54.0 06 54.0	
07	Low voltage alarm	24V model default setting:22.0 07 22.0	Low-voltage alarm: 24V model:(default 22.0Vdc) setting range :18V to 25V setting increase or decrease of 0.1V. 48V model: (default 44.0Vdc) setting range :36V to 50V setting increase or decrease of 0.1V.
		48V model default setting:44.0 07 44.0	

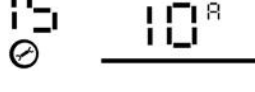
08	Low voltage Shutdown	<p>24V model default setting:21.0</p>  <p>48V model default setting:42.0</p> 	<p>Low Voltage Shutdown: 24V model:(default 21.0Vdc) setting range :18V to 25V setting increase or decrease of 0.1V. 48V model: (default 42.0Vdc) setting range :36V to 50V setting increase or decrease of 0.1V.</p>
10	AC charge	<p>default</p> 	<p>(default 30A) setting range is 0A to 80A, the increment or decrement is 10A per click. Note:when the AC charging current is Set to '0A',if PV,battery and Utility exist At the same time ,the PV will only charge The battery and the load is powered by Utility.and the grid-tie function is not available.</p>
11	Single and Parallel setting	<p>default</p>  <p>single-phase parallel</p>  <p>A phase</p>  <p>B phase</p>  <p>C phase</p>  <p>Please note: 1.when three-phase parallel,make sure that A-phase is the host; 2.after the parallel parameters are modified,the device must be restarted to be effective;</p>	<p>Single enable</p> <p>single-phase parallel enable</p> <p>A-phase parallel enable</p> <p>B-phase parallel enable</p> <p>C-phase parallel enable</p>

12	AC input voltage range	APL (default) 	If selected, acceptable AC input voltage range will be within 120-280VAC.
		UPS 	If selected, acceptable AC input voltage range will be within 170-280VAC.
13	AC+Solar Total charging current	Default 	(default 60A) setting range is 10A to 100A, the increment or decrement is 10A per click. NOTE: If the charging current needs to reach 100A,solar input voltage must be more than 350v
14	Setting voltage Point back to battery mode when selecting "SBU priority" or "PUL priority" in Program 01	24V model default setting:27.0vdc 	24V model: 27.0Vdc(default) setting range :20V to 29V 48V model: 54.0Vdc(default) setting range :40V to 58V setting increase or decrease of 0.1V.
		48V model default setting:54.0vdc 	
15	Discharge limited current		OFF: default ; discharge current limited disable
			setting range :10A to 200A setting increase or decrease of 5A . NOTE: if you work in "PV priority mode" or "SBU priority mode", when the loads is greater than the current limiting point, it will automatically switch to utility mode.
16	Discharge limiting current time		Discharge limiting current time:5S NOTE: when the load current is greater than the current limiting point, the inverter will turn off the output after 5 seconds. setting range :1S to 5S setting increase or decrease of 1S
17	Lithium battery discharge stop		Default:6% When the battery capacity of the lithium battery is lower than the set point, the inverter stops discharging and output will be turned off. setting range :1% to 60% setting increase or decrease of 1%.

18	Lithium battery charge stop		Default:96% When the battery capacity of the lithium battery is higher than the set point, the inverter stops charging setting range :60% to 100% setting increase or decrease of 1%.
19	Battery equalization	Battery equalization enable: 	Battery equalization disable: (default)
		Note: 1.if “User-Defined” is selected in program 04,this program can be set up. 2.after the device is turned off, you need to reset the battery equalization enable.	
20	Battery equalization voltage	24V model default setting:29.2vdc 	24V model: 29.2Vdc(default) setting range :24V to 30.5V 48V model: 58.4Vdc(default) setting range :48V to 61V setting increase or decrease of 0.1V.
		48V model default setting:58.4vdc 	
21	Battery equalized time	60min(default) 	setting range is from:5 min to 900 min increment of each click is 5 min
22	Battery equalized timeout	120min(default) 	setting range is from:5 min to 900 min increment of each click is 5 min
23	Equalization interval	30days(default) 	setting range is from:0 to 90 days increment of each click is 1 day
24	Equalization activated immediately	Enable 	Disable(default)
		NOTE:1. If equalization function is enabled in program 19, this program can be set up. If “Enable” is selected in this program, it's to activate battery equalization immediately and LCD main page will shows“E9”. If “Disable” is selected, it will cancel equalization function until next activated equalization time arrives based on program 23 setting. At this time, E9 ” will not be shown in LCD main page.	

5.5 Parallel function operation instructions

(Maximum of nine parallel machines)

1 **CAUTION:**It is forbidden for inverter to share the same solar panel group.

2. Connecting the parallel communication line and power cable as shown below

Warning: All inverters must share the same model.

3. Set the parameters of each inverter separately (working mode, single - phase parallel function).

Warning:When working in parallel, the working mode of each inverter must be the same working mode, output voltage,frequency.

4. After setting the parameters, turn on each inverter in turn.

WRINGING:for each group of PV,only one inverters can be connected,otherwise ,it may damage inverters.

Two inverters i n parallel :

NOTE:The following picture is only a schematic diagram of the equipment .If the actual chassis does not conform to the schematic due to a structural upgrade, it is subject to prior notice.

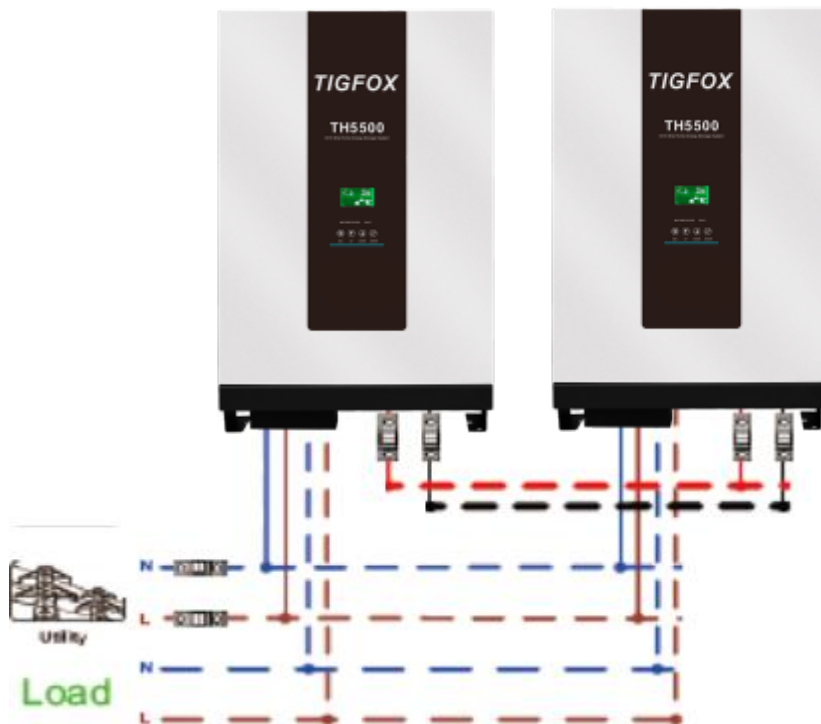

Communication Connection :

Red line is Inverter Parallel port(18), Green line is Inverter Current sharing port(17),

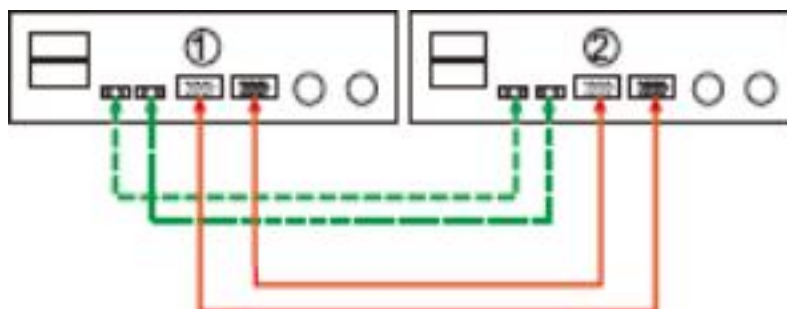

Three-phase parallel:

1. **CAUTION:**It is forbidden for inverter to share the same solar panel group.

2. Connecting the parallel communication line and power cable as shown below

Warning:All inverters must share the same battery pack when paralleling

3. Set the parameters of each inverter independently (working mode, single-phase parallel function, three-phase parallel function and set A/B/C phase sequence).

Warning:When working in parallel, the working mode of each inverter must be the same working mode.

5. After setting the parameters, first turn on the A phase inverter and then turn on each inverters in turn.

One inverter in each phase:

WRINGING:Do not connect the current sharing cable between the inverters which are in different phase. Otherwise ,it may damage inverters .

Power connection:

NOTE:The following picture is only a schematic diagram of the equipment .If the actual chassis does not conform to the schematic due to a structural upgrade, it is subject to prior notice.

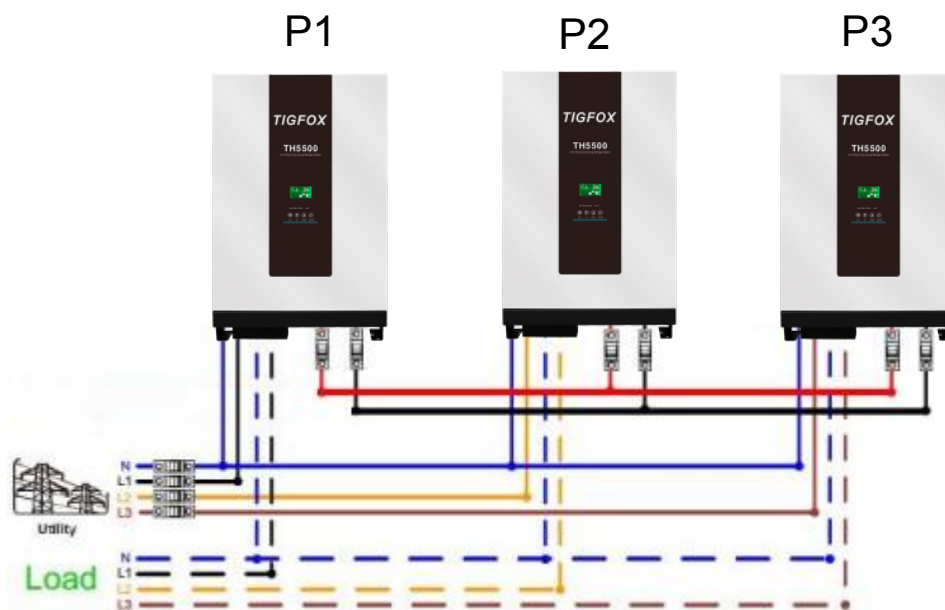

Communication connection: Red line is Inverter Parallel port(18)

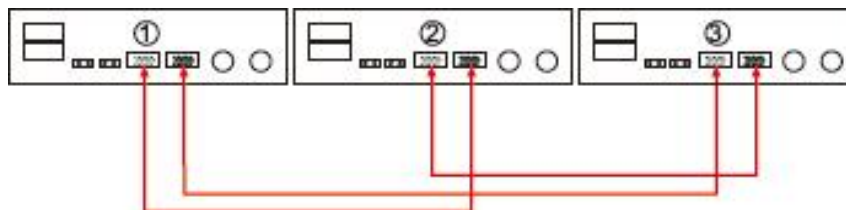

5.6 Fault Reference Code

Fault code	Fault event
01	Bus voltage is too high
02	Inverter voltage is too high
03	Inverter voltage is too low
04	Bus soft start failure
05	Overload fault
06	Output short circuited
07	Battery voltage is too low
08	Inverter soft start failure
09	Bus voltage is too low
10	Parallel fault
11	Over temperature
12	Battery voltage is too high
13	A phase lost
14	B phase lost
15	C phase lost
16	AC output voltage and frequency setting is different
17	AC input voltage and frequency detected different
18	Power feedback protection
19	Firmware version inconsistent
20	Current sharing fault
23	PV is over current
24	PV over temperature

25	PV overload
26	PV boost fault

5.7 Warning Indicator

Warning code	Warning Event
01	Battery voltage is too low
02	Input voltage is too low
03	Input voltage is too high
04	Overload
05	Over temperature
06	Fan is locked when inverter is on
07	Battery voltage is too high
08	Discharge over current
21	PV voltage is too low
22	PV voltage is too high
39	BMS communication lost

6.TROUBLE SHOOTING

Problem	LCD/LED/Buzzer	Possible cause	What to do
Unit shuts down automatically during start up process	LCD/LED and buzzer will be active then complete off	The battery voltage is too low	1. Re-charge battery. 2. Replace battery
No response after power on	No indication	1. The battery voltage is too low. 2. Internal fuse tripped	1. Contact repair center for replacing the fuse. 2. Re-charge battery. 3. Replace battery.
Mains exist but the unit works in battery mode	Input voltage is displayed as '0' on the LCD and green LED is flashing	Input protector is triggered	Check if AC breaker is turned on and AC wiring is connected well.
	LED is flashing	Insufficient quality of AC power	1. Check if AC wires are too thin and/or too long. 2. Check if generator (if applied) is working well or if input voltage range setting is correct.
When the unit is turned on, internal relay is switched on and off repeatedly	LCD display and LED flashing	Battery is disconnected	Check if battery wires are connected well
Buzzer beeps continuously and red LED is on	warning code 06	Fan fault	Replace the fan
	warning code 05	Internal temperature of inverter component is over 85°C	Check whether the environment around the equipment well ventilated
	warning code 07	The battery voltage is too high	check if spec and quantity of batteries are meet requirements
		battery is over charged	Return to repair center
	warning code 08	discharge over current	Please check whether the discharge current of Item 15 is lower than the discharge current of the inverter
	Fault code 10	Parallel fault	Please check if the connection between the inverters is loose

Buzzer beeps continuously and red LED is on	Fault code 06	Output short circuited	Check if wiring is connected well and remove abnormal load
	Fault code 05	Overload error , the inverter is overload 100% and overload time reaches the upper limit	Reduce the connected load by switching off some equipment
	warning code 22	If PV input voltage is higher than specification, the output power will be derated. At this time, if connected loads is higher than derated output power, it will cause overload.	Reduce the number of PV modules in series or the connected load
	Fault code 02/03	Output abnormal(Inverter voltage below than 180VAC or is higher than 260VAC)	1. Reduce the connected load 2. Return to repair center
	Fault code 01/04/06	Internal components failed	Return to repair center
	Fault code 23	Over current or surge	Remove abnormal load or check PV input
	Fault code 01	Bus voltage is too high	Restart the unit if the error happens again please return to repair center
	Fault code 09	Bus voltage is too low	
	Fault code 02/03	Output voltage is unbalanced	
	Fault code 11	Internal temperature of inverter component is over 85°C	Check whether the environment around the equipment well ventilated
	Fault code 12	The battery voltage is too high	Check if spec and quantity of batteries are meet requirements
		Battery is over-charged	Return to repair center

Buzzer beeps continuously and red LED is on	fault code 13/14/15	Phase loss	1. check whether three-phase power is connected 2. check whether the inverter turns on three-phase parallel
	fault code 16	AC output voltage and frequency setting is different	Check whether the output voltage and frequency of each inverter are set the same
	Fault code 17	AC input voltage and frequency detected different	Check whether the input voltage and frequency of each inverter are set the same
	Fault code 18	Power feedback protection	1.restart the inverter. 2.check if L/N cables are not Connected reversely in all inverters. 3.for parallel system in single phase ,make sure the sharing are connected in all inverters. For supporting three-phase system, make sure the sharing cables are connected in the inverters in the same phase. and disconnected in the inverters in different phase.
	Fault code 19	Firmware version inconsistent	1. update all inverter firmware to the same version 2. if the problem remains ,please contact your installer.
	Fault code 20	The output current of each inverter is different	1. check if sharing cables are connected well and restart the inverter. 2. if the problem remains ,please contact your installer.
	Warning 39	BMS communication lost	check whether the communication of lithium battery is normal.

7. SPECIFICATIONS

Table 1 Solar Mode specifications

MODEL	5.5KW/51.2VDC
Rated output power	5.5KW
PV Input Max Power	5.5KW
PV operating voltage range	120-450VDC
PV normal operating voltage	280-360VDC
Normal output voltage	230VAC
Output voltage range	230 ± 5%VAC
Normal output current	24A
Efficiency(DC/AC)	≥92%
Frequency	50/60Hz
Overload protection	MPPT will close immediately as long as the input power is greater than the maximum output power
PV Max input current	20A

Table 2 Line Mode specifications

Input Voltage Waveform	Pure sine wave (utility or generator)
Normal Input Voltage	230VAC
Low Loss Voltage	120VAC±7V (wide range) 170VAC±7V(narrow range)
Low Loss Return Voltage	130VAC±7V (wide range) 180VAC±7V(narrow range)
High Loss Voltage	280VAC±7V
High Loss Return Voltage	270VAC±7V
Max AC Input Voltage	300VAC
Normal Input Frequency	50Hz / 60Hz (Auto detection)
Low loss Frequency	40±1Hz
Low loss Return Frequency	42±1Hz
High loss Frequency	70±1Hz
High loss Return Frequency	67±1Hz
Output short circuit protection	Circuit Breaker
Efficiency (Line Mode)	>95% (Rated R load, battery full charged)
Communication	USB , RS232 ,RS485,WIFI ,CAN
Humidity	0-90% RH(No-condensing)
Operation temperature	0°C-50°C
Storage temperature	-15°C-60°C

Table 3 Charge Mode specifications

INVERTER MODEL	5.5KW
Charging Algorithm	3-Step
Utility Charging Mode	
AC Charging Current	0/10/20/30/40/50/60/70A/80Amp (@V _{IP} =230Vac)
Bulk Charging Voltage	48.0-60.0vdc (Default:56 vdc)
Floating Charging Voltage	48.0-60.0vdc (Default:54vdc)
Charging Curve	
Max. charging current(Solar+AC)	100A
Over-charging voltage	60vdc

Table 4 Inverter Mode specifications

Normal DC voltage	51.2V
Waveform	Pure sine wave
Output voltage range	230VAC±5%
Output frequency	50/60Hz±1Hz
Peak Efficiency	≥92%
Power factor	1.0
Overload protection	20s@101%~120% load , 10s@121%~150% load, 5s@≥150% load
Transfer time	10ms typical (UPS) 20ms typical (APL)
Protection features	Low voltage protection; High voltage protection Overload protection ; Over-temperature protection Short circuit protection; Over-charge protection; Battery reverse protection
Cold start voltage	46.0VDC
Low voltage alarm(optional)	36.0-50.0VDC
Low voltage alarm recovery	44.0VDC
Low voltage shutdown(optional)	36.0-50.0VDC
High voltage alarm recovery	60.0VDC
Dimension(LxWxH)mm	785X530X170
Net Weight (KG)	42kg
Gross Weight (KG)	43.5kg

8. BATTERY LCD INTORDUCE

8.1. Main Menu Page:

After power on/sleep activation, the welcome interface will be displayed. Press MENU to enter the main menu page. As shown in the figure below:



8.2 Battery parameter collection page:

When the cursor ">>" points to BMS Status, press ENTER to enter the Battery parameter page, as shown in the following figure:

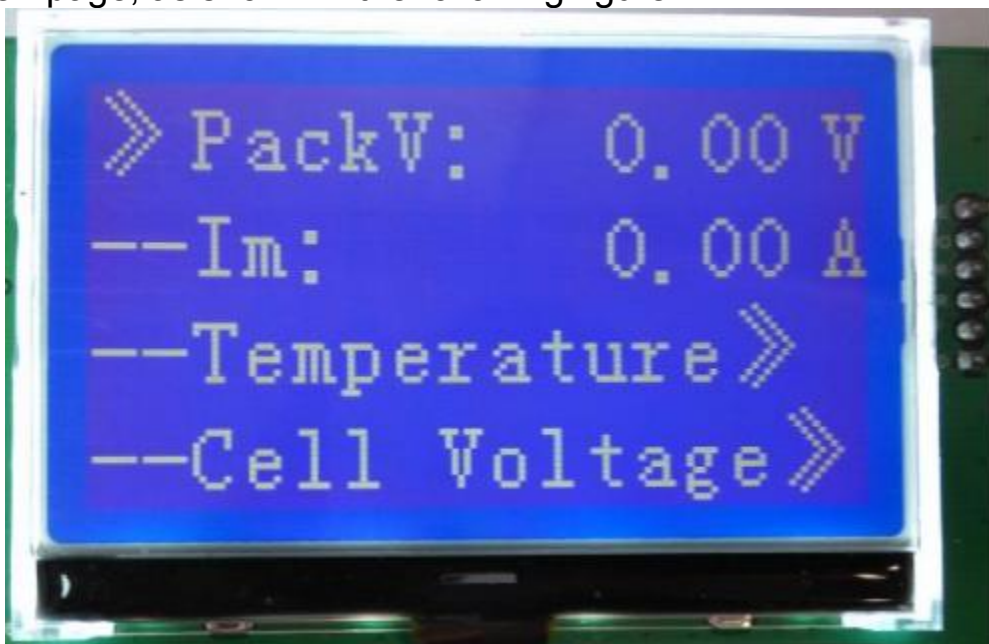

8.3 Buttons Introduce:

8.3.1. There are four touch buttons in panel: MENU,ESC,DWON,ENTER

8.3.2. Each item starts with "» " or "--", where "» " represents the current cursor position. Press DOWN to move the cursor position downward; The item ending with "» " indicates that the item has content that is not displayed. Press ENTER to enter the corresponding page.

8.3.3. Press ESC to return to the previous directory; At any position, press the MENU key to return to the main menu page

8.3.4. In the sleep state, press any key to activate the display screen

9. BATTERY INFORMATIONS

9.1 Nominal Capacity: 100Ah/5120Wh(LiFePO4)

9.2 Cycles: >3000 Cycles

9.3 Max.Discharge current: 100A

9.4 Max. Charge current: 100A

9.5 Nominal Voltage: 51.2Vdc

9.6 Voltage Range: 44.8Vdc ~58.4Vdc

9.7 BMS Protection Functions:

9.7.1 Charge over current, Charge over voltage, Charge high temperature, Charge low temperature protections;

9.7.2 Discharge over current, Discharge short circuit, Discharge under voltage, Discharge high temperature, Discharge low temperature protections

9.7.3 Charging current limiting function

10. Installation dimension drawing

NOTE: The following picture is only a schematic diagram of the equipment. If the actual chassis does not conform to the schematic due to a structural upgrade, it is subject to prior notice.

